



Systèmes pour portes
coulissantes en verre
Systems for sliding glass doors

ASSA ABLOY

Systèmes
pour portes
coulissantes
en verre

Systems for sliding
glass doors

Slice 60

Système ultra compact, avec dimensions réduites (50X60 mm), le SLICE s'intègre avec discrétion à tous types d'intérieurs :

- Roulement à billes pour minimiser le bruit,
- Amortisseurs hydrauliques en fin de course,
- Guide au sol avec patins.

Ultra compact system, with its slim line measurements (50X60 mm), SLICE fits with discretion into all types of interiors :

- Trolleys to decrease noise,
- Hydraulic shock absorbers,
- Special floor guide.

Références / References

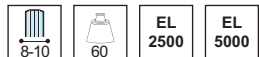

Kits complets / Complete Kits

Système pour porte simple coulissante, rail lg 2500 mm
System for single sliding door, rail length 2500 mm

Alu. anodisé argent brossé
Brushed anodised alu. silver

Alu. anodisé ANINOX
Brushed anodised alu.

Laqué Blanc
Lacquered white

KSL60M1.12

KSL60M1.36

KSL60M1.51

Système pour porte double coulissante, rail lg 5000 mm
System for double sliding doors, rail length 5000 mm

KSL60M2.12

KSL60M2.36

KSL60M2.51

Références / References

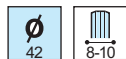

Anneau de tirage
Ring pull

Chromé brillant
Bright chromium

Chromé mat
Matt chromium

SL27.30

SL27.31

LES + PRODUITS

The + product

Pas d'encoche

Compact

Silencieux

No notch

Compact

Noiseless

Ce kit comprend

KSL60M1.**

- Un rail avec cache rail lg 2500 mm, 2 chariots avec pinces, 2 butées, 2 embouts, 1 guide au sol et 1 anneau de tirage SL27

KSL60M2.**

- Un rail avec cache rail lg 5000 mm, 4 chariots avec pinces, 4 butées, 2 embouts, 2 guides au sol et 2 anneaux de tirage SL27

This kit includes

KSL60M1.**

- One rail and cover length 2500 mm, 2 glass clamping trolleys, 2 stops, 2 end covers, 1 floor guide and 1 ring pull SL27

KSL60M2.**

- One rail and cover length 5000 mm, 4 glass clamping trolleys, 4 stops, 2 end covers, 2 floors guide and 2 ring pulls SL27

Caractéristiques techniques

- Poids maxi par porte : 60 kg
- Sans encoche
- Pour verre trempé de 8 et 10 mm (non fourni)
- Fixation au mur ou au plafond
- Rail : aluminium anodisé ou laqué RAL

Technical features

- Maximum door weight : 60 kg
- No notch required
- For 8 and 10 mm thick toughened glass (not supplied)
- Wall or ceiling installation
- Rail : Anodised aluminium or RAL lacquered finish

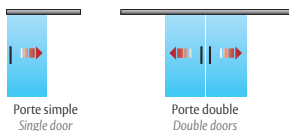
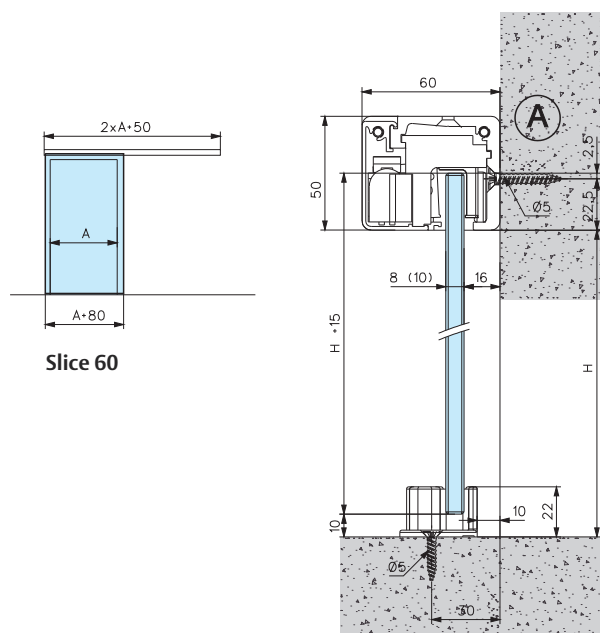

Idéal
pour l'intérieur
de la maison
Ideal for home
interiors

Slice Synchro

Ouverture et fermeture simultanée des deux portes grâce à la simple poussée d'une main !
Simultaneous opening of both doors by a simple movement with one hand



Systemes
pour portes
coulissantes
en verre
*Systems for sliding
glass doors*

Références / References



Kits complets / Complete Kits



Alu. anodisé argent brossé
Brushed anodised alu. silver



Alu. anodisé ANINOX
Brushed anodised alu.



Laqué Blanc
Lacquered white

Système synchronisé pour porte double coulissante, rail lg 5000 mm
Simultaneous opening system for double sliding doors, rail length 5000 mm

KSL560M2.12

KSL560M2.36

KSL560M2.51

Ce kit comprend

KSL560M2.**

- Un rail avec cache rail lg 5000 mm, 4 chariots avec pinces, 3 butées, 2 embouts, 2 guides au sol, 2 anneaux de tirage SL27 et un Kit synchronisation de porte

This kit includes

KSL560M2.**

- One rail and cover length 5000 mm, 4 glass clamping trolleys, 3 stops, 2 end covers, 2 floors guide, 2 ring pulls SL27 and a doors synchronisation Kit

Caractéristiques techniques

- Poids maxi par porte : 60 kg
- Sans encoche
- Pour verre trempé de 8 et 10 mm (non fourni)
- Fixation au mur ou au plafond
- Rail : aluminium anodisé ou laqué RAL
- Pour porte largeur mini 800 mm

Technical features

- Maximum door weight : 60 kg
- No notch required
- For 8 and 10 mm thick toughened glass (not supplied)
- Wall or ceiling installation
- Rail : Anodised aluminium or RAL lacquered finish
- Minimum door width : 800 mm

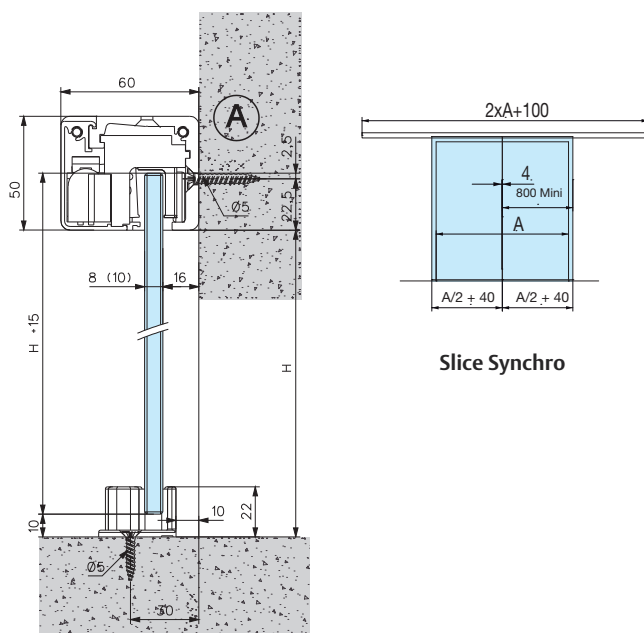

Slice Synchro

Systèmes
pour portes
couissantes
en verre
*Systems for sliding
glass doors*

Slice 60

Références / References

EL
5000

Rail et profil / Rail and profile

	Alu. anodisé argent brossé <i>Brushed anodised alu. silver</i>	Alu. anodisé ANINOX <i>Brushed anodised alu.</i>	Laqué Blanc <i>Lacquered white</i>
Rail + capot coulissant SLICE <i>Rail and cover SLICE</i>	SL10.12	SL10.36	SL10.51
Rail + capot coulissant SLICE et volume fixe ep. 8 et 10 mm <i>Rail and cover SLICE and fixed panels, for 8 and 10 mm glass</i>	SL15/10.12	SL15/10.36	SL15/10.51
Rail + capot coulissant SLICE et volume fixe ep. 12 mm <i>Rail and cover SLICE and fixed panels, for 12 mm glass</i>	SL15/12.12	SL15/12.36	SL15/12.51
Profil U 15x15x15x2 pour volume fixe ep. 8mm <i>U-profile 15x15x15x2 for fixed panels, for 8 mm glass</i>	U151515.12	U151515.36	U151515.51
Profil U 20x20x20x2 pour volume fixe ep. 10 et 12mm <i>U-profile 20x20x20x2 for fixed panels, for 10 and 12 mm glass</i>	U202020.12	U202020.36	U202020.51



Kit Chariots / Trolley Kit

kit de 2 chariots avec pince, 1 guide au sol, 2 arrêts <i>Kit of 2 glass clamping trolleys with 1 floor guide, 2 stops</i>	SL60.99
kit de 4 chariots avec pinces pour 2 portes synchro, 2 guides au sol, 3 arrêts <i>Kit of 4 glass clamping trolleys for 2 panels synchro with 2 floor guides, 3 stops</i>	SLS60M2.99
Guide au sol réglable pour verre 8/10 mm <i>Adjustable floor guide for 8/10 mm glass</i>	SL600.99

Poignées, boutons, serrures : voir page accessoires / *Handles, knobs, locks : see page accessories*

Paire d'embouts / End covers

	Argent métallisé <i>Metallic silver</i>	Effet INOX <i>Stainless steel effect</i>	Laqué Blanc <i>Lacquered white</i>
Paire d'embouts pour rail SL10. <i>Set of 2 end covers for rail SL10.</i>	SL195.12	SL195.36	SL195.51

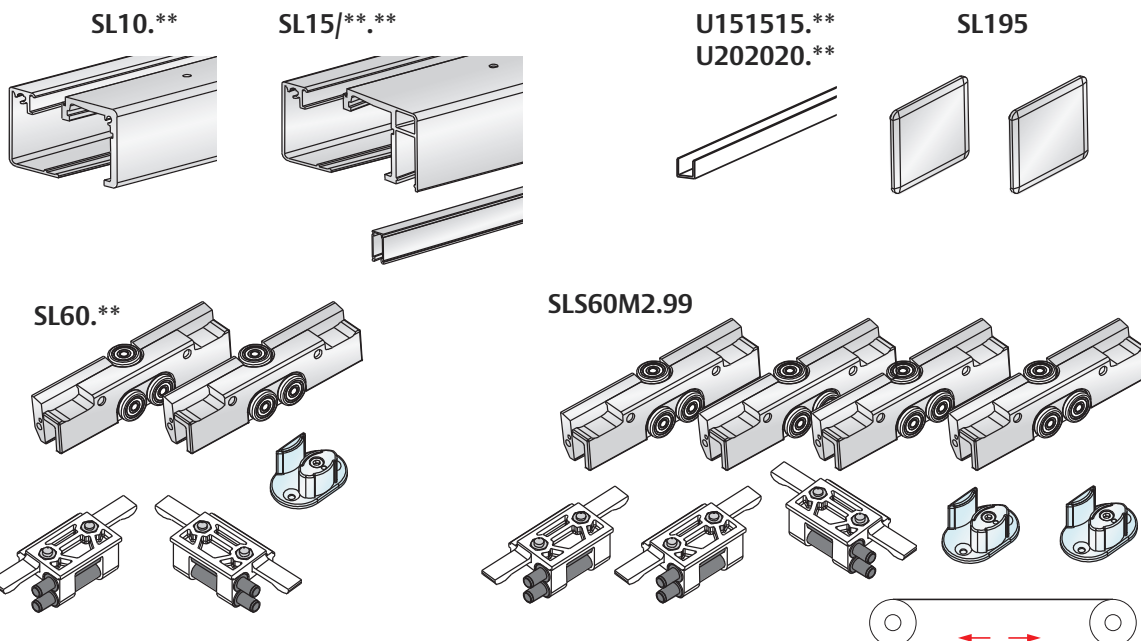
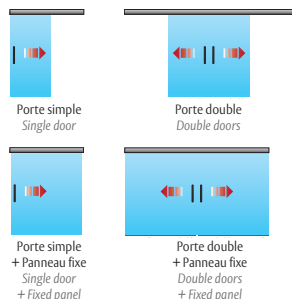

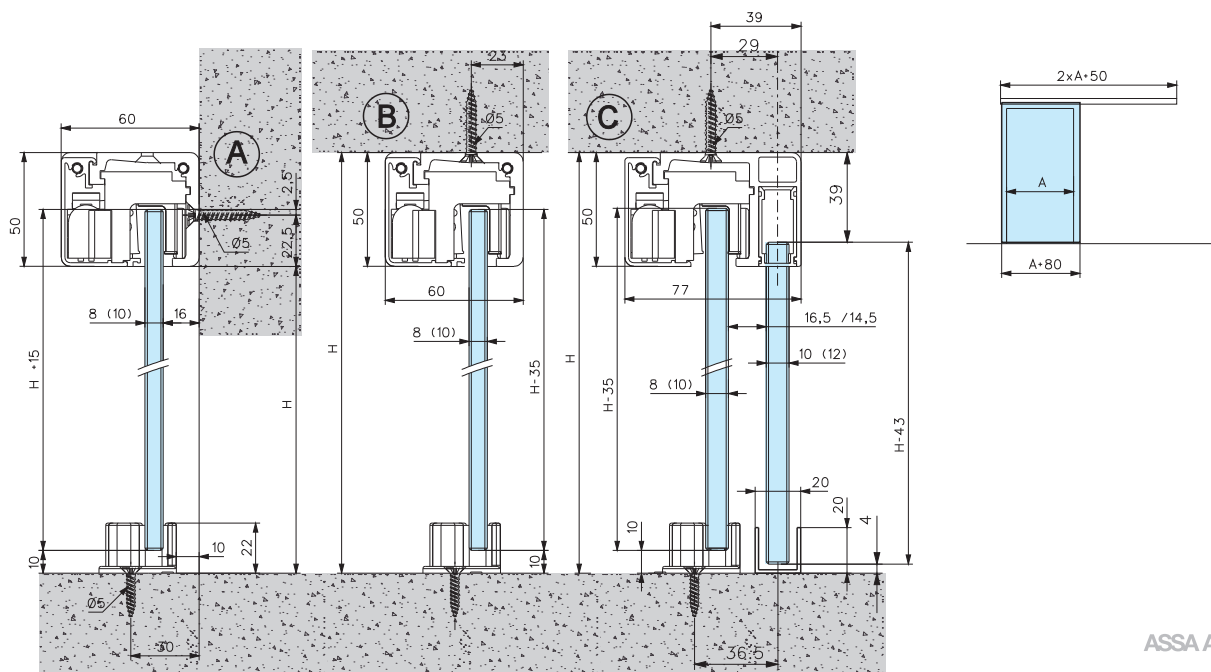

Systèmes
pour portes
coulissantes
en verre
*Systems for sliding
glass doors*

Slice 100

Système ultra compact, avec dimensions réduites (50X60 mm), le SLICE s'intègre avec discrétion à tous types d'intérieurs :

- Roulement à billes pour minimiser le bruit,
- Amortisseurs hydrauliques en fin de course,
- Guide au sol avec patins.

Ultra compact system, with its slim line measurements (50X60 mm), SLICE fits with discretion into all types of interiors :

- *Trolleys to decrease noise,*
- *Hydraulic shock absorbers,*
- *Special floor guide.*



LES + PRODUITS

The + product

Pas d'encoche

Compact

Silencieux

Spécial grande
ouverture

No notch

Compact

Noiseless

*Perfect for
large opening*

Références / References



Kit complet / Complete Kit



Alu. anodisé argent brossé
Brushed anodised alu. silver



Alu. anodisé ANINOX
Brushed anodised alu.



Laqué Blanc
Lacquered white

Système pour porte simple coulissante, rail lg 5000 mm
System for single sliding door, rail length 5000 mm

KSL100M1.12

KSL100M1.36

KSL100M1.51

Système pour porte double coulissante, rail lg 5000 mm
System for double sliding doors, rail length 5000 mm

KSL100M2.12

KSL100M2.36

KSL100M2.51

Références / References



Anneau de tirage
Ring pull



Chromé brillant
Bright chromium



Chromé mat
Matt chromium

SL27.30

SL27.31



Porte simple
Single door

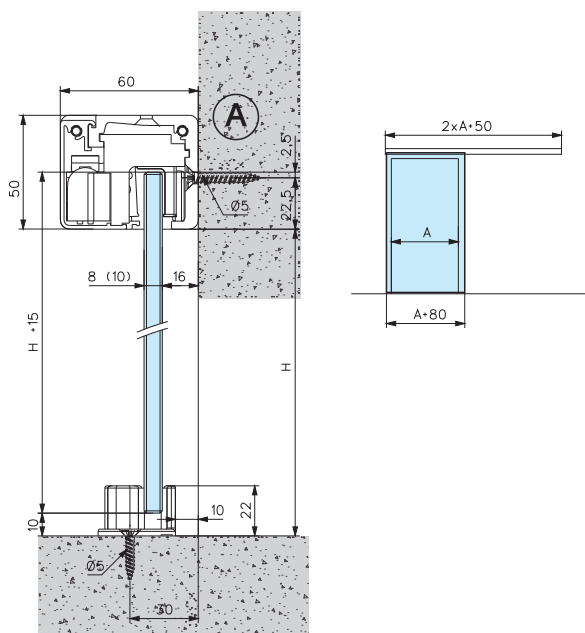

*Idéal
pour l'intérieur
de la maison
Ideal for home
interiors*



Ce kit comprend

- Un rail avec cache rail lg 5000 mm, 2 chariots avec pinces, 2 butées, 2 embouts, 1 guide au sol et 1 anneau de tirage SL27

This kit includes

- *One rail and cover length 5000 mm, 2 glass clamping trolleys with 2 stops, 2 end covers, 1 floor guide and 1 ring pull SL27*

Caractéristiques techniques

- Poids maxi par porte : 100 kg
- Sans encoche
- Pour verre trempé de 8 et 10 mm (non fourni)
- Fixation au mur ou au plafond
- Rail : aluminium anodisé ou laqué RAL

Technical features

- *Maximum door weight : 100 kg*
- *No notch required*
- *For 8 and 10 mm thick toughened glass (not supplied)*
- *Wall or ceiling installation*
- *Rail : Anodised aluminium or RAL lacquered finish*

Systemes
pour portes
coulissantes
en verre
*Systems for sliding
glass doors*

Slice 100

Références / References

EL
5000

Rail et profil / Rail and profile

	Alu. anodisé argent brossé <i>Brushed anodised alu. silver</i>	Alu. anodisé ANINOX <i>Brushed anodised alu.</i>	Laqué Blanc <i>Lacquered white</i>
Rail + capot coulissant SLICE <i>Rail and cover plate SLICE</i>	SL10.12	SL10.36	SL10.51
Rail + capot coulissant SLICE et volume fixe ep. 8 et 10 mm <i>Rail and cover SLICE and fixed panels, for 8 and 10 mm glass</i>	SL15/10.12	SL15/10.36	SL15/10.51
Rail + capot coulissant SLICE et volume fixe ep. 12 mm <i>Rail and cover SLICE and fixed panels, for 12 mm glass</i>	SL15/12.12	SL15/12.36	SL15/12.51
Profil U 15x15x15x2 pour volume fixe ep. 8mm <i>U-profile 15x15x15x2 for fixed panels, for 8 mm glass</i>	U151515.12	U151515.36	U151515.51
Profil U 20x20x20x2 pour volume fixe ep. 10 et 12mm <i>U-profile 20x20x20x2 for fixed panels, for 10 and 12 mm glass</i>	U202020.12	U202020.36	U202020.51



Kit Chariots / Trolley Kit

kit de 2 chariots avec pince, 1 guide au sol, 2 arrêts <i>Kit of 2 glass clamping trolleys with 1 floor guide, 2 stops</i>	SL100.99
Guide au sol pour porte coulissante <i>Adjustable floor guide for sliding doors</i>	SL600.99

Poignées, boutons, serrures : voir page accessoires / Handles, knobs, locks : see page accessories

Paire d'embouts / End covers

	Argent métallisé <i>Metallic silver</i>	Effet INOX <i>Stainless steel effect</i>	Laqué Blanc <i>Lacquered white</i>
Paire d'embouts pour rail SL10. <i>Set of 2 end covers for rail SL10.</i>	SL195.12	SL195.36	SL195.51

LES + PRODUITS

The + product

Pas d'encoche

Compact

Silencieux

Spécial grande
ouverture

No notch

Compact

Noiseless

*Perfect for
large opening*

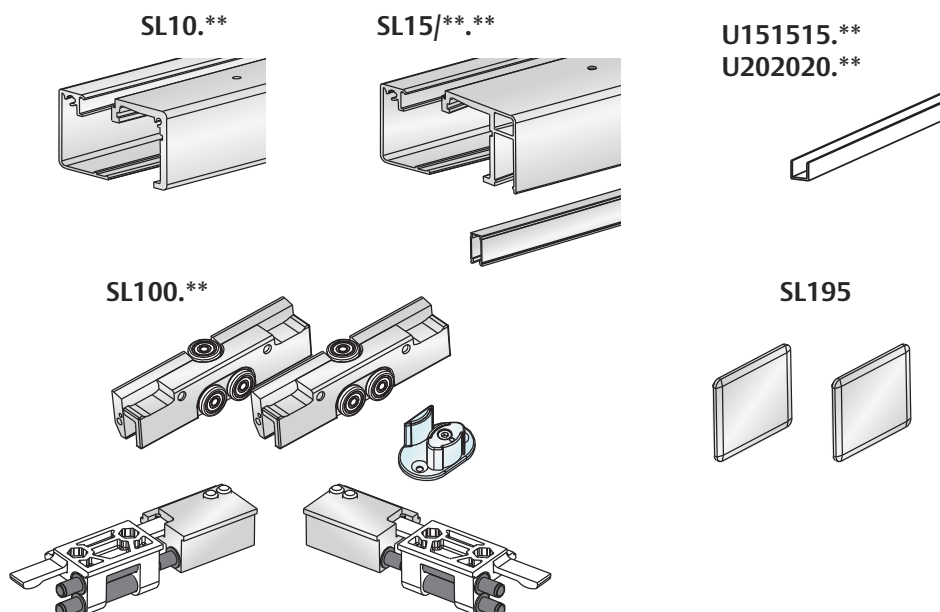
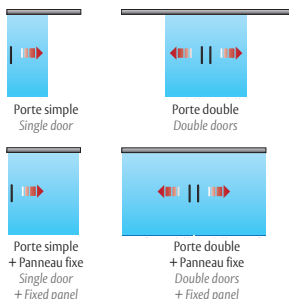

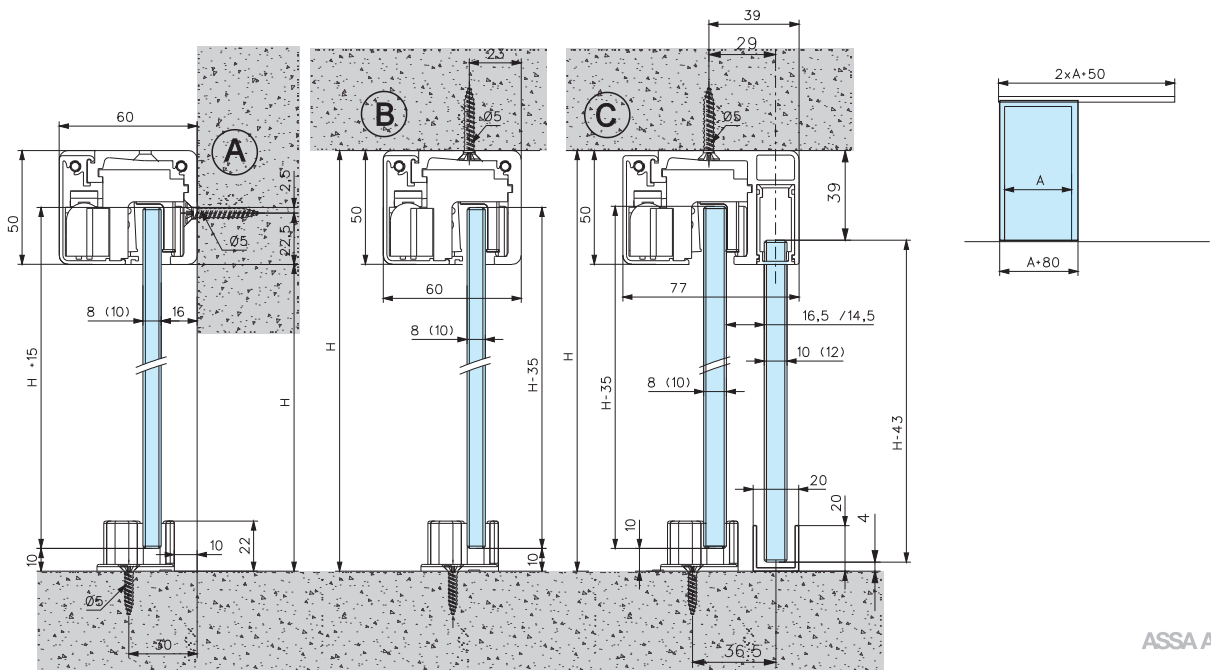



Ce kit comprend

KSL81M1.**

- Un rail avec cache rail lg 2500 mm, 2 chariots avec pinces, 1 butée automove, 1 butée, 2 embouts, 1 guide au sol et 1 anneau de tirage SL27

KSL81M2.**

- Un rail avec cache rail lg 5000 mm, 2 chariots avec pinces, 2 butées automove, 2 butées, 2 embouts, 2 guides au sol et 2 anneaux de tirage SL27

KSL82M1.**

- Un rail avec cache rail lg 2500 mm, 2 chariots avec pinces, 2 butées automove, 2 embouts, 1 guide au sol et 1 anneau de tirage SL27

KSL82M2.**

- Un rail avec cache rail lg 5000 mm, 2 chariots avec pinces, 4 butées automove, 2 embouts, 2 guides au sol et 2 anneaux de tirage SL27

Caractéristiques techniques

- Poids maxi par porte : 80 kg
- Sans encoche
- Pour verre trempé de 8 et 10 mm (non fourni)
- Fixation au mur ou au plafond
- Rail : aluminium anodisé ou laqué RAL

This kit includes

KSL81M1.**

- One rail and cover length 2500 mm, 2 glass clamping trolleys with 1 stop, 1 automove, 2 end covers, 1 floor guide and 1 ring pull SL27

KSL81M2.**

- One rail and cover length 5000 mm, 2 glass clamping trolleys with 2 stops, 2 automoves, 2 end covers, 2 floor guides and 2 rings pull SL27

KSL82M1.**

- One rail and cover length 2500 mm, 2 glass clamping trolleys with 2 automoves, 2 end covers, 1 floor guide and 1 ring pull SL27

KSL82M2.**

- One rail and cover length 5000 mm, 2 glass clamping trolleys with 4 automoves, 2 end covers, 2 floor guides and 2 rings pull SL27

Technical features

- Maximum door weight : 80 kg
- No notch required
- For 8 and 10 mm thick toughened glass (not supplied)
- Wall or ceiling installation
- Rail : Anodised aluminium or RAL lacquered finish

Systèmes
pour portes
coulissantes
en verre
*Systems for sliding
glass doors*

Slice Automove

Références / References

EL
5000

Rail et profil / Rail and profile

	Alu. anodisé argent brossé <i>Brushed anodised alu. silver</i>	Alu. anodisé ANINOX <i>Brushed anodised alu.</i>	Laqué Blanc <i>Lacquered white</i>
Rail + capot coulissant SLICE <i>Rail and cover SLICE</i>	SL10.12	SL10.36	SL10.51
Rail + capot coulissant SLICE et volume fixe ep. 8 et 10 mm <i>Rail and cover SLICE and fixed panels, for 8 and 10 mm glass</i>	SL15/10.12	SL15/10.36	SL15/10.51
Rail + capot coulissant SLICE et volume fixe ep. 12 mm <i>Rail and cover SLICE and fixed panels, for 12 mm glass</i>	SL15/12.12	SL15/12.36	SL15/12.51
Profil U 15x15x15x2 pour volume fixe ep. 8mm <i>U-profile 15x15x15x2 for fixed panels, for 8 mm glass</i>	U151515.12	U151515.36	U151515.51
Profil U 20x20x20x2 pour volume fixe ep. 10 et 12mm <i>U-profile 20x20x20x2 for fixed panels, for 10 and 12 mm glass</i>	U202020.12	U202020.36	U202020.51



Kit Chariots / Trolley Kit

kit de 2 chariots avec pince, 1 guide au sol, 1 amortisseur Automove et 1 butée. <i>Kit of 2 glass clamping trolley with 1 floor guide, 1 Automove and 1 stop.</i>	SL81.99
kit de 2 chariots avec pince, 1 guide au sol, 2 amortisseurs Automove. <i>Kit of 2 glass clamping trolley with 1 floor guide, 2 Automoves.</i>	SL82.99
Guide au sol réglable pour verre 8/10 mm <i>Adjustable floor guide for 8/10 mm glass</i>	SL600.99

Poignées, boutons, serrures : voir page accessoires / Handles, knobs, locks : see page accessories

Paire d'embouts / End covers

	Argent métallisé <i>Metallic silver</i>	Effet INOX <i>Stainless steel effect</i>	Laqué Blanc <i>Lacquered white</i>
Paire d'embouts pour rail SL10. <i>Set of 2 end covers for rail SL10.</i>	SL195.12	SL195.36	SL195.51

SL10.**

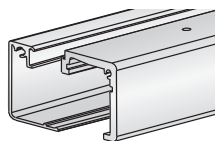

SL15/**.**

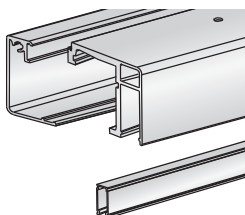

U151515.**
U202020.**



SL195

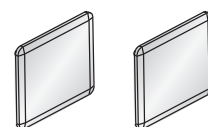

SL81.**

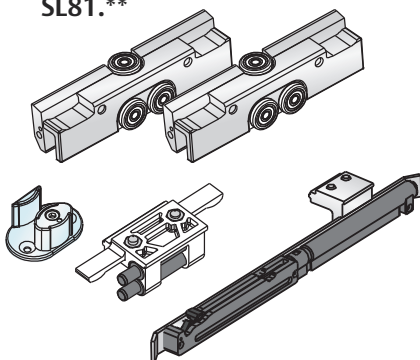

SL82.**

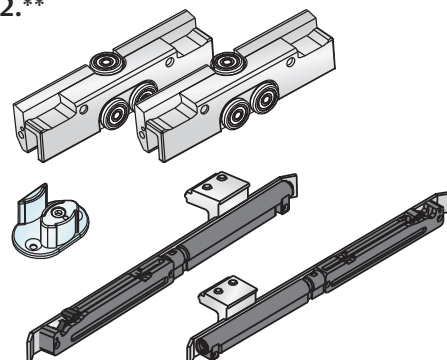

5 ans de garantie

Testé à plus
de 100 000
manœuvres

5 years guarantee

Tested more than
100 000 cycles





Kit Chariots / Trolley Kit

kit de 2 chariots avec pince, 1 guide au sol, 1 amortisseur Automove et 1 butée.
Kit of 2 glass clamping trolley with 1 floor guide, 1 Automove and 1 stop.

SL81.99

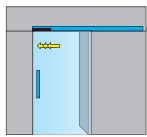

1 x SL10.** + 1 x SL81.99
+ SL195.**

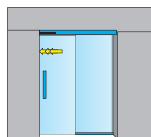

1 x SL15.** + 1 x SL81.99 + Profil U

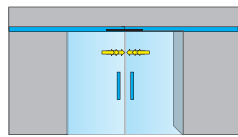

1 x SL10.** + 2 x SL81.99
+ SL195.**

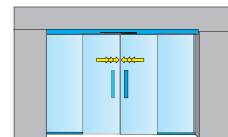

1 x SL15.** + 2 x SL81.99 + Profil U

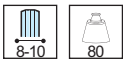

Kit Chariots / Trolley Kit

kit de 2 chariots avec pince, 1 guide au sol, 2 amortisseurs Automove.
Kit of 2 glass clamping trolley with 1 floor guide, 2 Automoves.

SL82.99

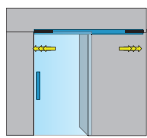

1 x SL10.** + 1 x SL82.99
+ SL195.**

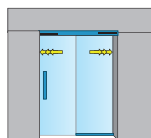

1 x SL15.** + 1 x SL82.99 + Profil U

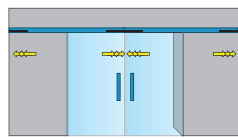

1 x SL10.** + 2 x SL82.99
+ SL195.**

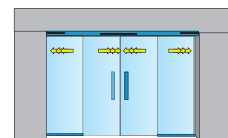

1 x SL15.** + 2 x SL82.99 + profil U

Poignées, boutons, serrures : voir page accessoires / Handles, knobs, locks : see page accessories

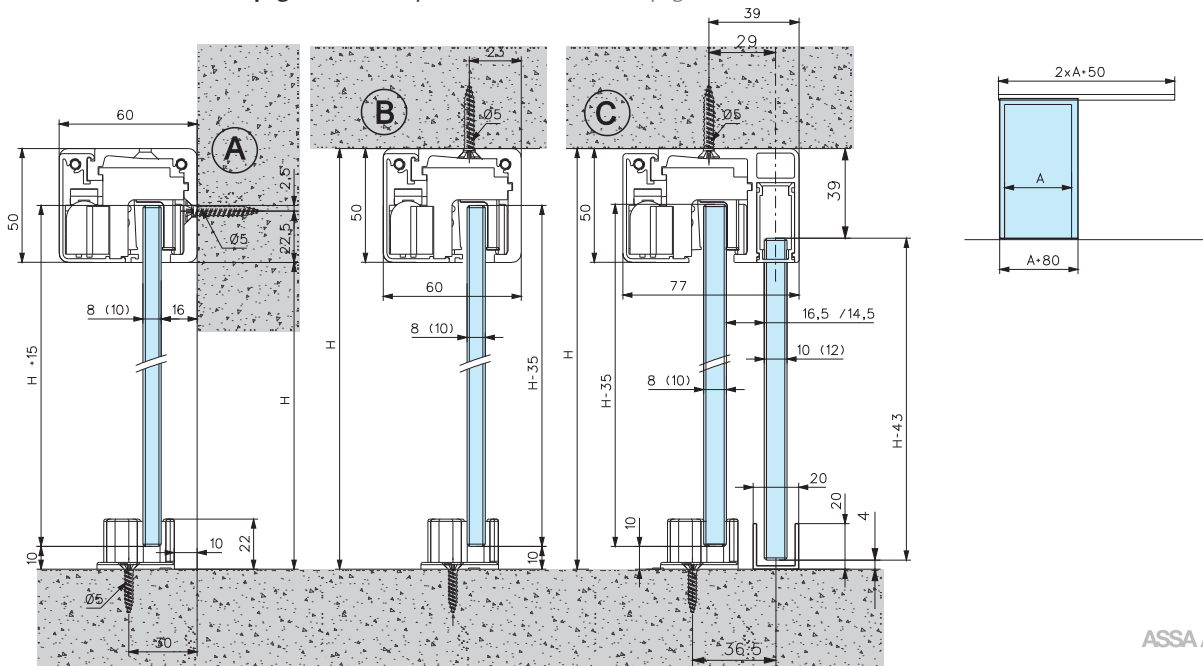

Systèmes
pour portes
coulissantes
en verre
*Systems for sliding
glass doors*

Magic Slide

Système coulissant invisible
Concealed sliding system



LES + PRODUITS

Système invisible :
pas de rail
sur le mur

Installation facile

Coulissant réversible
droite ou gauche

Invisible system :
no profile on the wall

Easy installation

Reversible right or left

Références / References



Kit complet



Alu. anodisé argent brossé
Brushed anodized alu. silver

Système pour porte simple coulissante réversible droite ou gauche
System for single sliding door reversible right or left

MSL80M1.12

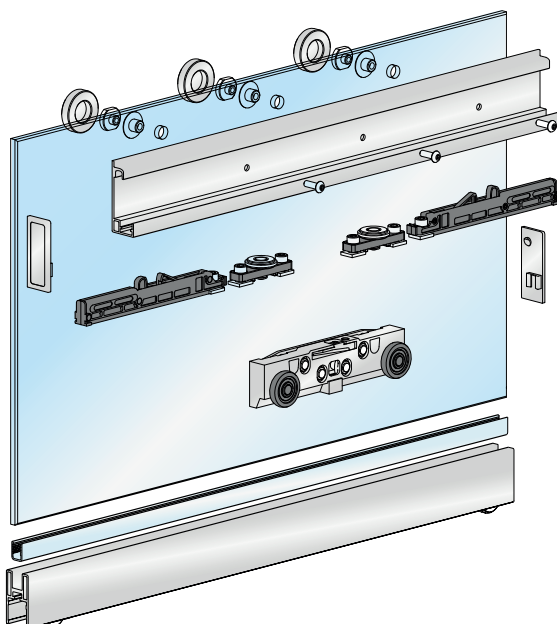
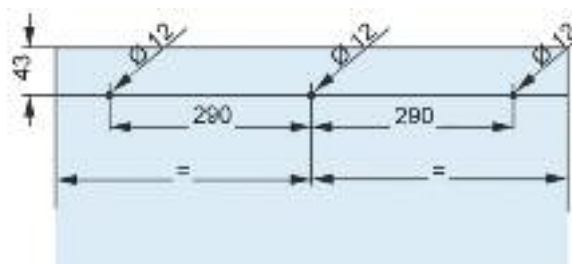

Ce kit comprend

- Un profil haut et bas en finition anodisé argent
- Un guide au sol
- 2 amortisseurs intégrés dans le mécanisme
- 2 roulettes intégrées dans le profil bas
- Des vis et cache-vis anodisés pour la fixation du verre sur le profil haut

This kit includes

- Top and bottom rail available in silver anodized finish
- A floor guide
- 2 Stops integrated into top rail
- 2 trolleys integrated into bottom rail
- Screws and anodized screw covers to assemble glass onto the top rail

3 Types d'installation / 3 Types of installation

Systèmes pour portes coulissantes en verre
Systems for sliding glass doors

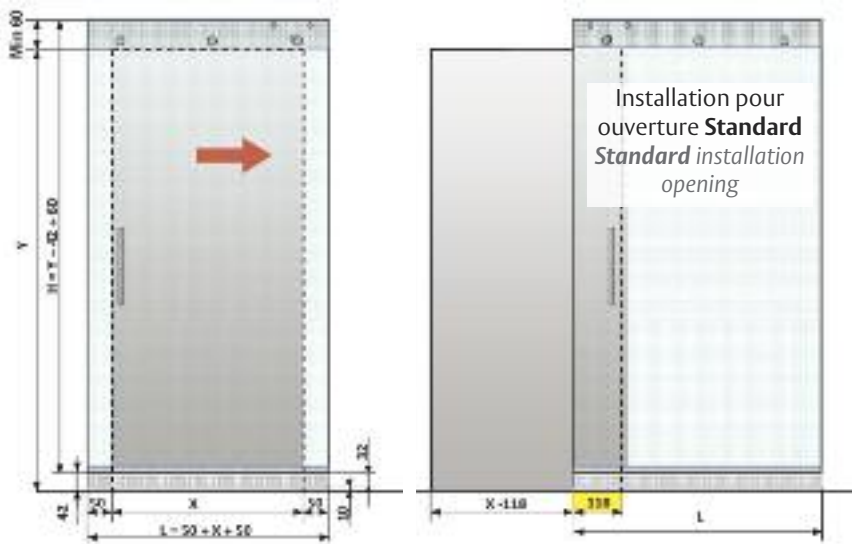

Caractéristiques techniques

- Recommandé pour porte intérieure
- Largeur de porte maxi 1100 mm
- Poids maxi par porte : 80 kg
- Pour verre trempé de 8 mm (non fourni)
- Fixation en applique sur linteau
- Mécanisme invisible
- Amortisseurs pour plus de sécurité et confort
- Système réversible droite ou gauche
- Montage sur 3 trous Ø 12 mm

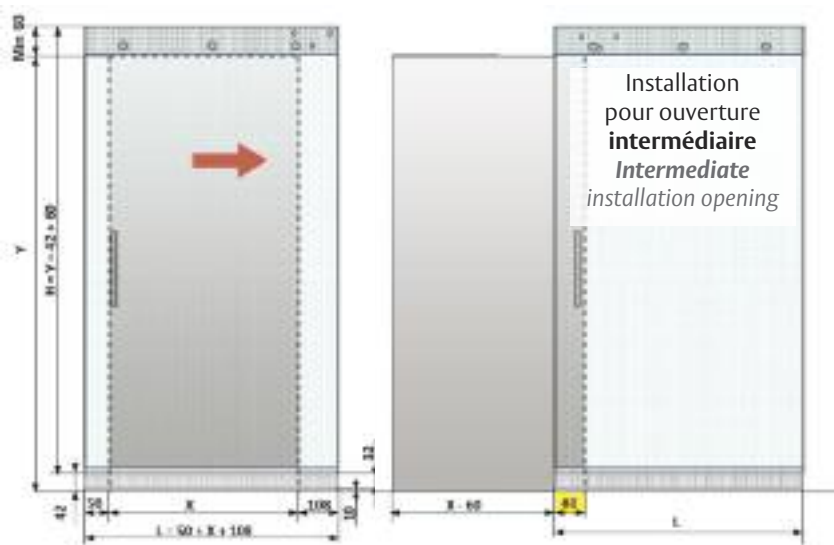

Technical features

- Recommended for inside doors
- Maximum door width 1100 mm
- Maximum door weight : 80 kg
- For 8mm thick toughened glass (not supplied)
- Wall mounted
- Invisible mechanism
- Cushioning of movement for safety and comfort
- Reversible system right or left
- Assembled onto 3 holes Ø 12 mm

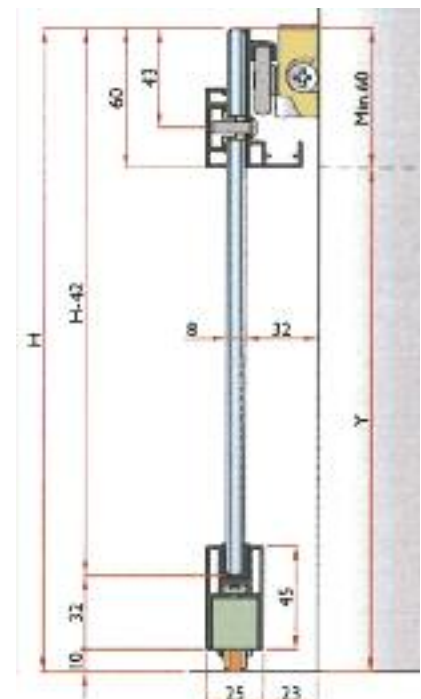
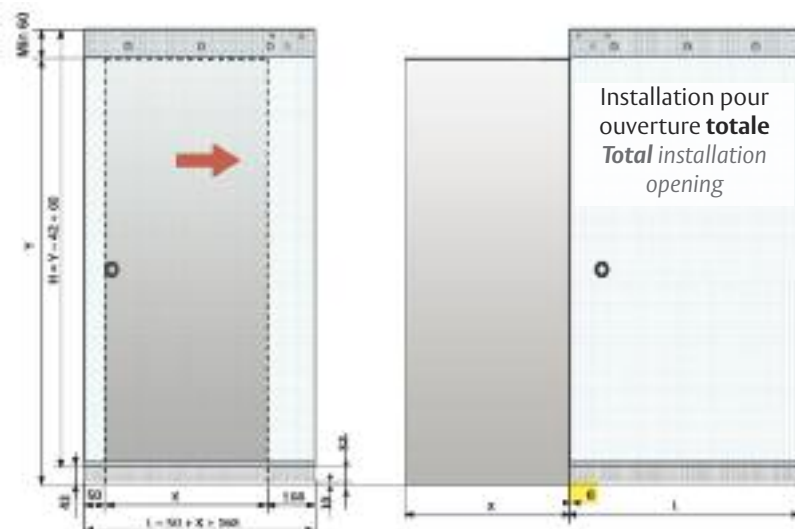

Systèmes
pour portes
coulissantes
en verre
*Systems for sliding
glass doors*

Slidematic

Les automatismes de portes Assa Abloy Glass vous assurent la solution la plus performante combinant transparence et mobilité. Une gamme complète d'accessoires vous permet un large choix de fonctions de sécurité et de contrôle d'accès.

Assa Abloy Glass automated door systems provide the best solution combining clarity and mobility. An exhaustive range of accessories allows you a variety of access control and safety features.

SLIDEMATIC 1



LES + PRODUITS

The + product

Idéal pour personne
à mobilité réduite

*Ideal for
disabled people*



Porte simple
Single doors

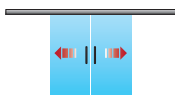

Porte double
Double doors

**Solutions coulissants automatiques d'intérieur
voir chapitre portes automatiques**

*For automatic interior sliding systems, please see the
chapter on automatic doors.*

Systèmes
pour portes
coulissantes
en verre
*Systems for sliding
glass doors*

SLIDEMATIC2



Tableau de synthèse

Technical features table

	MAGIC SLIDE	SLICE 60	SLICE AUTOMOVE	SLICE 100
Technique / Technical				
Poids maxi <i>Max load</i>	80 kg	60 kg	80 kg	100 kg
Hauteur maxi <i>Maximum height</i>	2600 mm	3000 mm	3000 mm	3000 mm
Épaisseur verre trempé <i>Toughened glass thickness</i>	8 mm	8-10 mm	8-10 mm	8-10 mm
Mécanisme invisible <i>Invisibe mechanism</i>	•			
Sans encoche <i>No notch</i>		•	•	•
Montage au mur <i>Wall installation</i>	•	•	•	•
Montage au plafond <i>Ceiling installation</i>		•	•	•
Fonction AUTOMOVE <i>AUTOMOVE</i>			•	
Fonction SYNCHRO <i>SYNCHRO</i>		•		
Dimensions / Sizes				
Hauteur rail <i>Rail height</i>		50	50	50
Fonctions / Functions				
Porte simple <i>Single door</i>	•	•	•	•
Porte double <i>Double door</i>		•	•	•
Partie fixe en verre <i>Fixed panel</i>		•	•	•
Finitions / Finishes				
Alu. anodisé argent brossé <i>Brushed anodised alu. silver</i>	•	•	•	•
Aluminium anodisé aninox <i>Brushed anodised alu.</i>		•	•	•
Laqué RAL <i>RAL lacquered finish</i>		•	•	•
Chromé brillant <i>Bright chromium</i>				
Chromé mat <i>Matt chromium</i>				



Systemes pour portes repliables
Folding door systems

ASSA ABLOY

Easyfold

EASYFOLD est un système coulissant repliable pour panneaux en verre, prévu aussi bien pour l'intérieur, que pour l'extérieur. Les panneaux sont assemblés en utilisant des charnières combinées avec des guides glissants dans un rail d'aluminium.

Un guide en U ou un seuil avec U de guidage dans le sol est nécessaire.

Les chariots sont équipés de roulements en acier inoxydable, qui couissent doucement et ne nécessitent pas d'entretien.

La paroi peut être sécurisée en utilisant un cale-pied, spécialement étudié.

EASYFOLD, peut être fermé à l'aide d'une serrure avec cylindre prévue sur le dernier panneau.

EASYFOLD is a sliding-and-folding glass panel system for use indoors and out. The panels are assembled using a combination of hinges and rollers sliding inside an aluminium top track.

A simple U-profile or threshold with U-shaped guide is required at floor level.

The trolleys are equipped with smooth sliding stainless steel bearings that are entirely maintenance-free.

The glass panels can be secured using a specially designed spring loaded toe operated clip lock.

EASYFOLD is locked using a cylinder lock fitted to the last panel.



LES + PRODUITS

Transparence totale

Total transparency

Caractéristiques techniques

- Largeur maximale par panneau : 750 mm
- Hauteur maximale par panneau : 2400 mm
- Poids maximal par panneau : 45 kg
- Pour verre trempé épaisseur : 8 ou 10 mm
- 6 panneaux repliables sur un même coté possible

Technical features

- Maximum panel width : 750 mm
- Maximum panel height : 2400 mm
- Maximum panel weight : 45 kg
- For 8 - 10 mm thick toughened glass (not supplied)
- Up to six panels can be assembled on same side

Encombrement des volumes repliés

Size of area for stacked panel

- 2 volumes / 2 panels = 80 mm
- 3 volumes / 3 panels = 120 mm
- 4 volumes / 4 panels = 170 mm
- 5 volumes / 5 panels = 210 mm
- 6 volumes / 6 panels = 250 mm

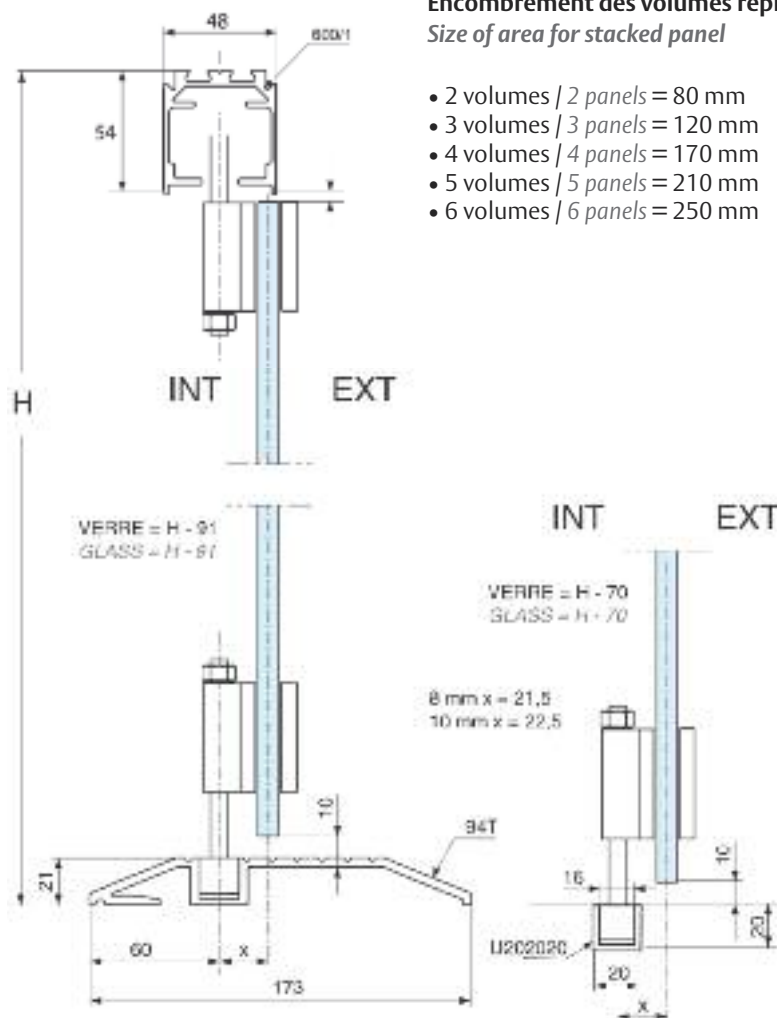

600/1.**

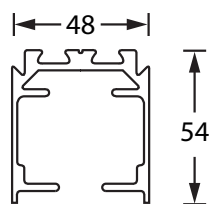

Références / References

EL
6000

Rail pour fixation plafond pour Easyfold
Track profile ceiling mounted for Easyfold



Alu. anodisé argent brossé
Brushed anodised alu. silver

600/1.12



Aluminium anodisé aninox
Brushed anodised alu.

600/1.36

94T.**

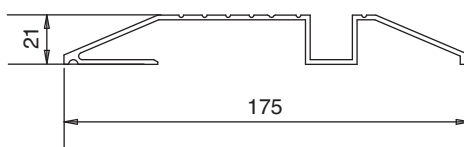

Références / References

EL
6000

Profil 'threshold' hauteur 21 mm
Built-up threshold profile height 21 mm



Alu. anodisé argent brossé
Brushed anodised alu. silver

94T.12



Aluminium anodisé aninox
Brushed anodised alu.

94T.36

U202020.**

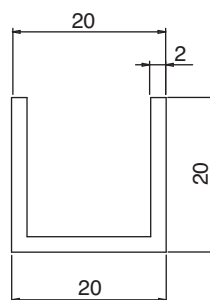

Références / References

EL
6000

Profil U 20x20x20x2 mm
U-profile 20x20x20x2 mm



Alu. anodisé argent brossé
Brushed anodised alu. silver

U202020.12



Aluminium anodisé aninox
Brushed anodised alu.

U202020.36

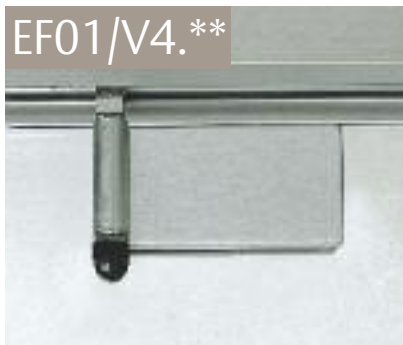

EF01/V4.**

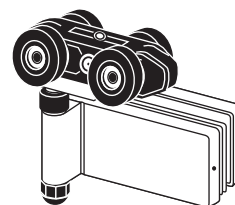

Références / References



Guide offset terminal à 4 roues avec charnière simple
4-wheeled offset end hanger with hinge



Alu. anodisé argent brossé
Brushed anodised alu. silver



Aluminium anodisé aninox
Brushed anodised alu.

EF01/V4.12

EF01/V4.36



EF02.**

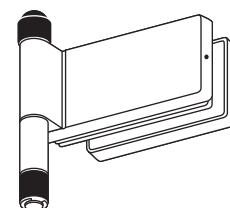

Références / References



Guide inférieur avec charnière simple
End guide with single hinge



Alu. anodisé argent brossé
Brushed anodised alu. silver



Aluminium anodisé aninox
Brushed anodised alu.

EF02.12

EF02.36



EF03.**

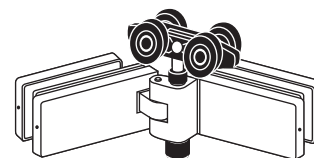

Références / References



Guide central à 4 roues avec charnière double
4-wheeled mid hanger with double hinge



Alu. anodisé argent brossé
Brushed anodised alu. silver



Aluminium anodisé aninox
Brushed anodised alu.

EF03.12

EF03.36

EF04.**

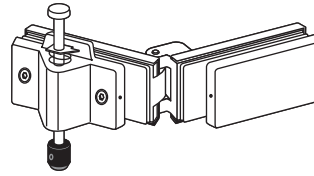
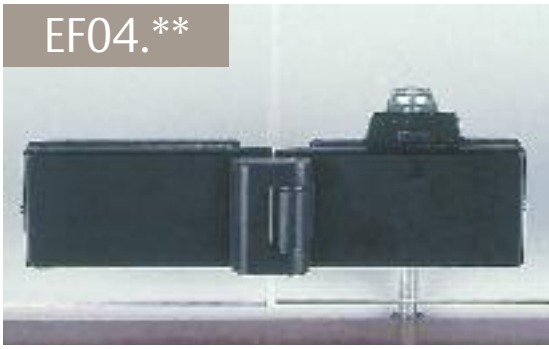

Systemes pour
portes repliables
Folding door
systems

Références / References



Charnière double avec cale-pied
(serrure seulement disponible en gris et noir laqué)
Double hinge with spring-loaded, foot-operated bolt
(lock only available in lacquered finish grey or black)



Alu. anodisé argent brossé
Brushed anodised alu. silver



Aluminium anodisé aninox
Brushed anodised alu.

EF04.12

EF04.36

EF06.**

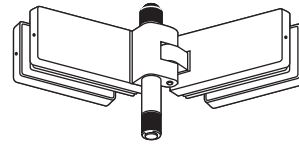

Références / References



Guide inférieur avec charnière double
Mid guide with double hinge



Alu. anodisé argent brossé
Brushed anodised alu. silver



Aluminium anodisé aninox
Brushed anodised alu.

EF06.12

EF06.36

EF07.**

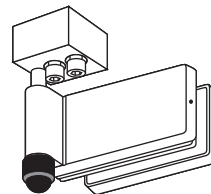

Références / References



Pivot supérieur avec charnière
Top pivot with hinge



Alu. anodisé argent brossé
Brushed anodised alu. silver



Aluminium anodisé aninox
Brushed anodised alu.

EF07.12

EF07.36

EF08.**

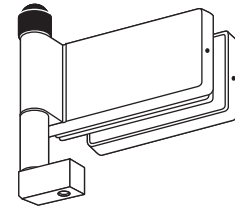

Références / References



Pivot inférieur avec charnière
Bottom pivot with hinge



Alu. anodisé argent brossé
Brushed anodised alu. silver



Aluminium anodisé aninox
Brushed anodised alu.

EF08.12

EF08.36



EF09.**

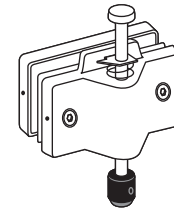
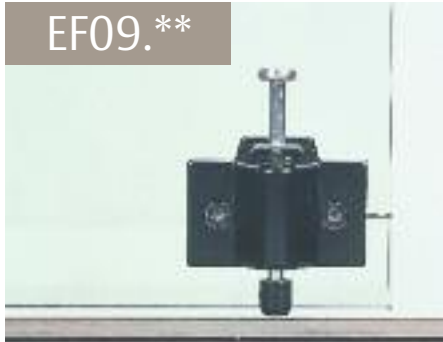

Références / References

Cale-pied pour verre
(disponible en gris et noir laqué)
Spring-loaded, foot-operated lock
(available in lacquered finish grey or black)



Alu. anodisé argent brossé
Brushed anodised alu. silver



Aluminium anodisé aninox
Brushed anodised alu.

EF09.12

EF09.36

V507

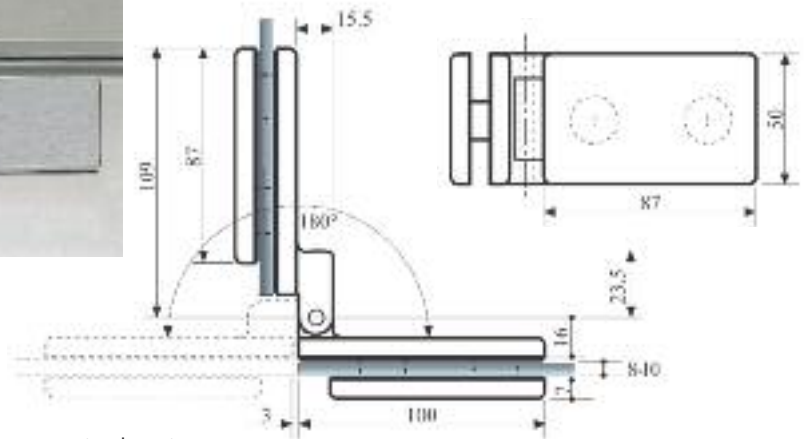

Références / References



Paumelle double verre/verre pour portes simple action
Glass to glass hinge for single action doors

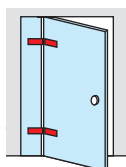

Laiton poli verni
Polished varnished brass



Alu. anodisé argent brossé
Brushed anodised alu. silver



Chromé brillant
Bright chromium



Chromé mat brossé
Brushed matt chromium



Aluminium anodisé Aninox
Brushed anodised alu.

V507.01

V507.12

V507.30.0

V507.33

V507.36

van

Systèmes pour
portes repliables
*Folding door
systems*



Easyfold

2 volumes - 2 panels

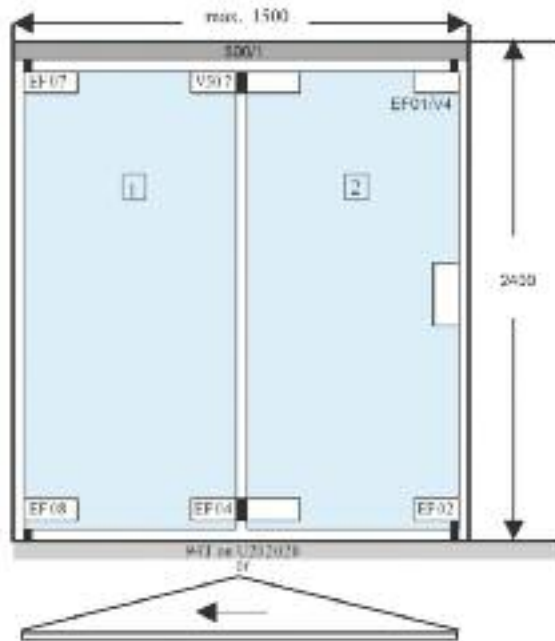

Accessoires nécessaires / References needed :

600/1 L = Largeur de l'ouverture en mm
L = Width of the opening in mm

94T ou/or U2020 L = Largeur de l'ouverture en mm
L = Width of the opening in mm

EF07	Q = 1
EF08	Q = 1
V507	Q = 1
EF04	Q = 1
EF01/V4	Q = 1
EF02	Q = 1

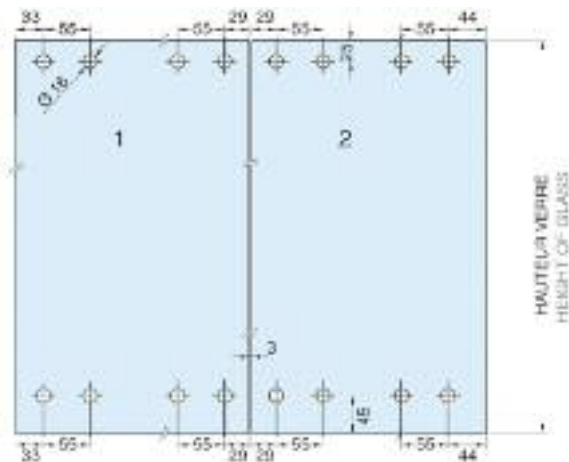

Hauteur verre = Hauteur de l'ouverture - 70 mm avec le U202020
= En cas de threshold - 91 mm avec le 94T

Panel height = Opening height - 70 mm with the U202020 profile
= If using threshold profile - 91 mm with the 94T profile

Easyfold

Systèmes pour
portes repliables
Folding door
systems

3 volumes - 3 panels

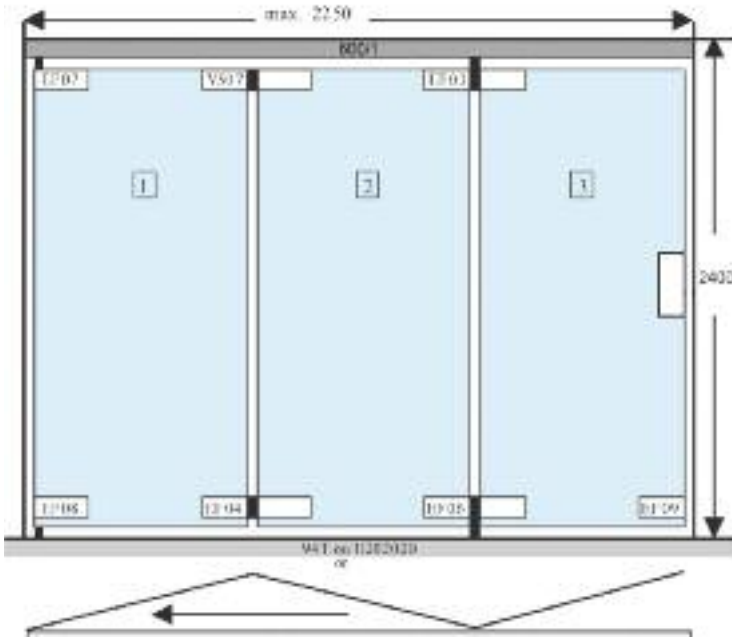

Accessoires nécessaires / References needed :

600/1 L = Largeur de l'ouverture en mm
L = Width of the opening in mm

94T ou/or U2020 L = Largeur de l'ouverture en mm
L = Width of the opening in mm

EF07	Q = 1
EF08	Q = 1
V507	Q = 1
EF04	Q = 1
EF03	Q = 1
EF06	Q = 1
EF09	Q = 1

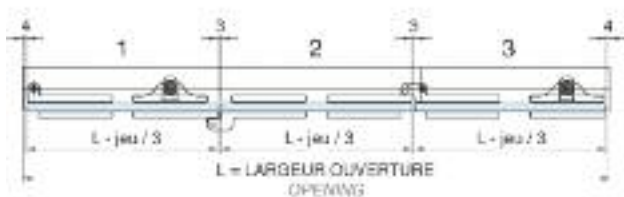
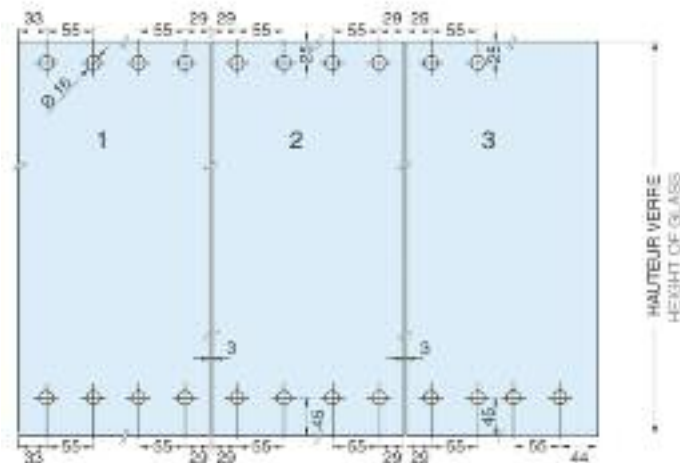

Hauteur verre = Hauteur de l'ouverture - 70 mm avec le U202020
= En cas de threshold - 91 mm avec le 94T

Panel height = Opening height - 70 mm with the U202020 profile
= If using threshold profile - 91 mm with the 94T profile

Easyfold

4 volumes - 4 panels

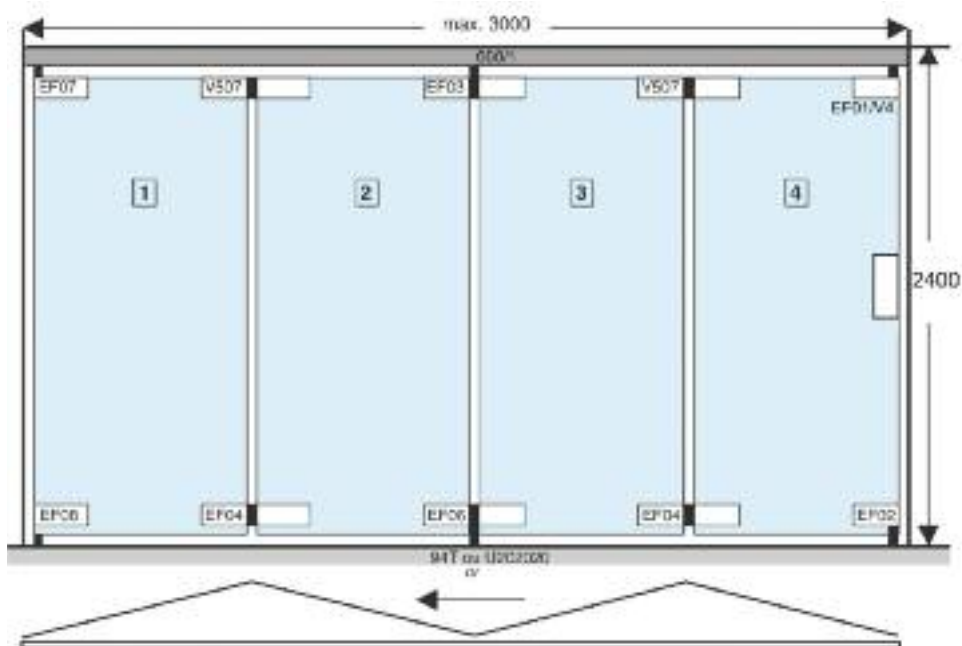

Accessoires nécessaires / References needed :

600/1 L = Largeur de l'ouverture en mm
L = Width of the opening in mm

94T ou/or U2020 L = Largeur de l'ouverture en mm
L = Width of the opening in mm

EF07 Q = 1

EF08 Q = 1

V507 Q = 2

EF04 Q = 2

EF03 Q = 1

EF01/V4 Q = 1

EF06 Q = 1

EF02 Q = 1

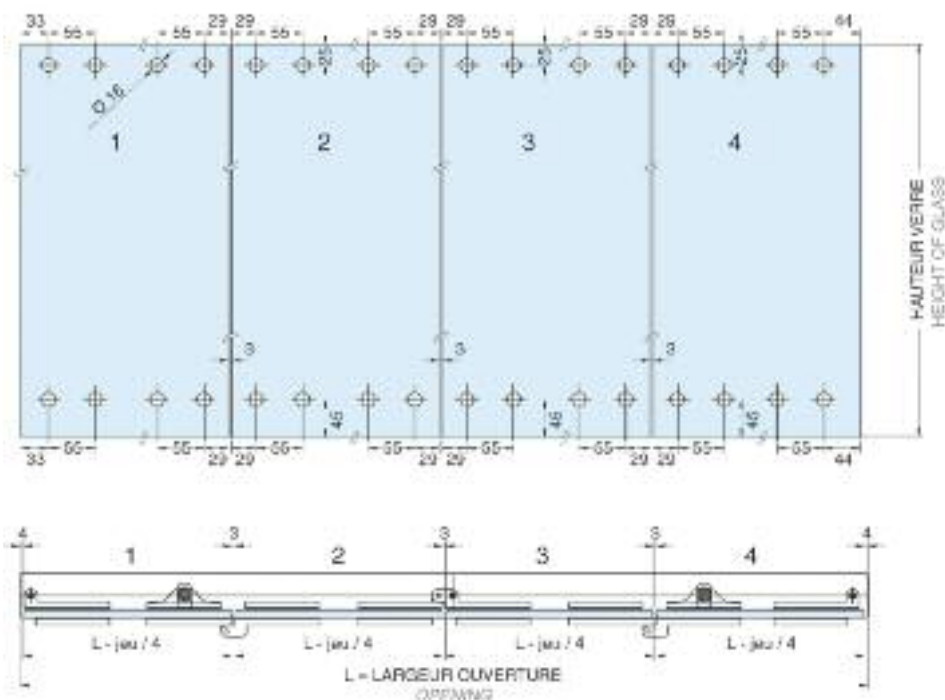

Hauteur verre = Hauteur de l'ouverture - 70 mm avec le U202020
= En cas de threshold - 91 mm avec le 94T

Panel height = Opening height - 70 mm with the U202020 profile
= If using threshold profile - 91 mm with the 94T profile

Easyfold

5 volumes - 5 panels

Systèmes pour
portes repliables
Folding door
systems

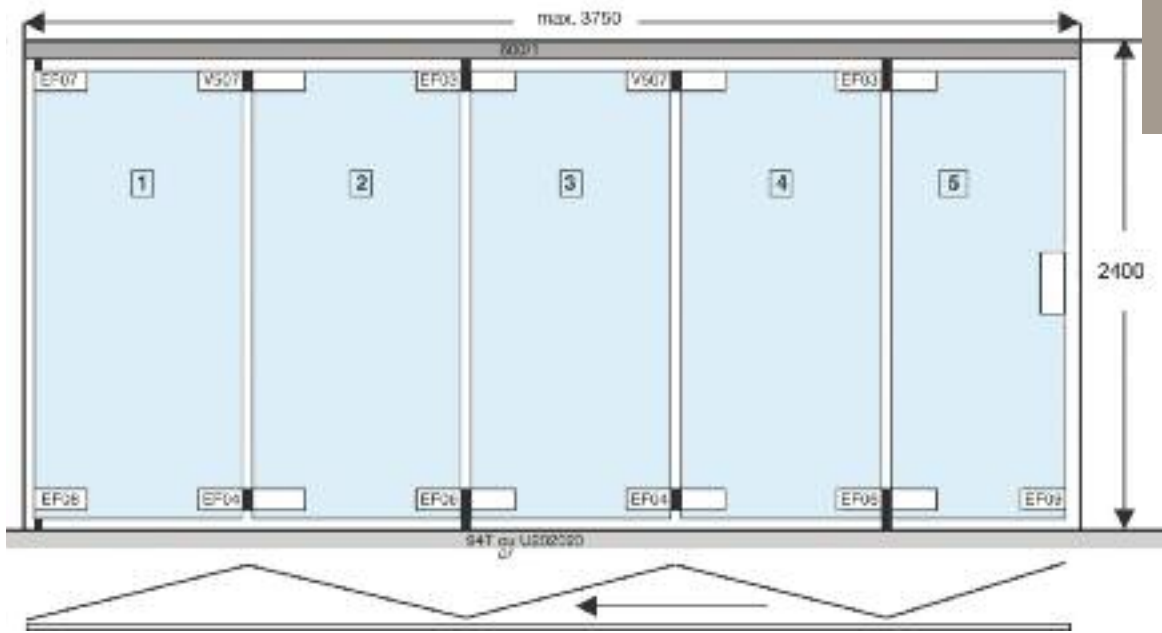

Accessoires nécessaires / References needed :

600/1 L = Largeur de l'ouverture en mm
L = Width of the opening in mm

94T ou/ou
U202020 L = Largeur de l'ouverture en mm
L = Width of the opening in mm

EF07	Q = 1
EF08	Q = 1
V507	Q = 2
EF04	Q = 2
EF03	Q = 2
EF06	Q = 2
EF09	Q = 1

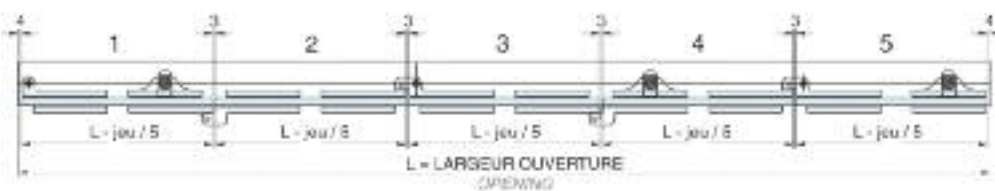
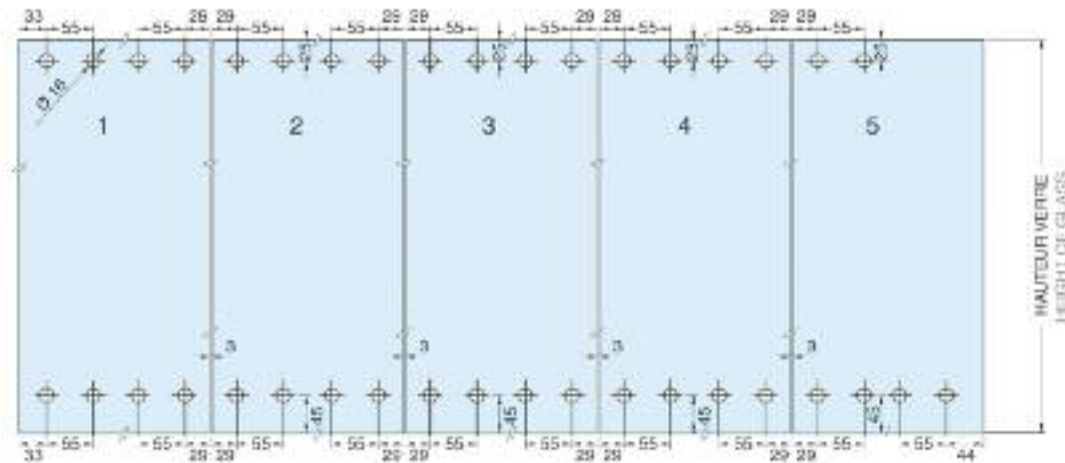

Hauteur verre = Hauteur de l'ouverture - 70 mm avec le U202020
= En cas de threshold - 91 mm avec le 94T

Panel height = Opening height - 70 mm with the U202020 profile
= If using threshold profile - 91 mm with the 94T profile



Systemes pour parois mobiles
Stacking door systems

ASSA ABLOY

Flexystack 250



Le système FLEXYSTACK 250 consiste en une paroi mobile comportant des panneaux suspendus. Le système convient aussi bien pour des parois intérieures que pour des parois extérieures. Les panneaux sont maniés individuellement et manuellement pour être installés dans leur position de rangement et ouvrir la totalité de la baie. Le rangement peut être réalisé de façon à ce que les panneaux restent hors de vue ou même rangés dans un emplacement à part, sans gêner l'ouverture.

FLEXYSTACK 250 est une paroi mobile, jusqu'à 250 kg par panneau, le rail a un design esthétique et le corps des rouleaux est en acier inoxydable avec une bande de roulement qui réduit le bruit.

The FLEXYSTACK 250 system consists of a mobile partition comprising suspended panels. Without floor guide, the system is suitable for both internal and external partitions. Each panel is placed manually into its storage position so that the entire bay can be opened up. The panels can be stored in such a way that they are out of sight or even stored in a separate location, without obstructing the entrance.

FLEXYSTACK 250 is a stacking door system, up to 250 kgs per panel, the track profile has an aesthetic design, the wheels of the stainless steel hangers are covered with a noise reducing material.

LES + PRODUITS

Grandes ouvertures
Modulable
Pas de guidage au sol

Large opening
Modularity
No floor guide



Alu. anodisé argent brossé
Brushed anodised alu. silver



Aluminium anodisé aninox
Brushed anodised alu.



Laqué RAL
Lacquered RAL

Caractéristiques techniques

FLEXYSTACK 250

- Poids maximum 250 kg par panneau
- Hauteur maximum 3000 mm
- Pour l'épaisseur en verre 10 mm et 12 mm, aucune préparation en verre requise

Technical features

FLEXYSTACK 250

- Maximum weight 250 kg per panel
- Maximum door height 3000 mm
- For glass thickness 10 mm and 12 mm, no glass preparation required





Chariot / Trolley



Aiguillage / Panel diverter

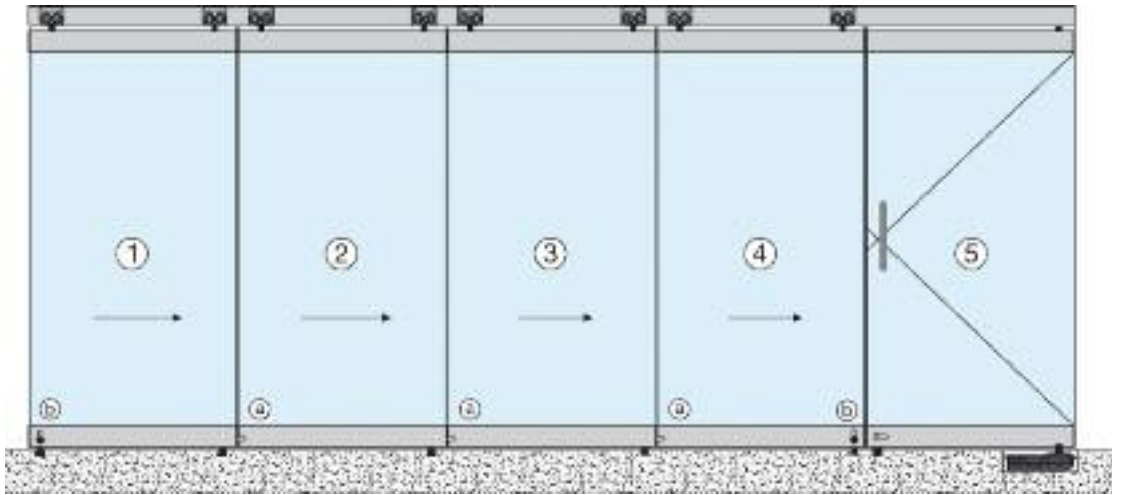

Fermetures : différentes possibilités
Locking : different possibilities

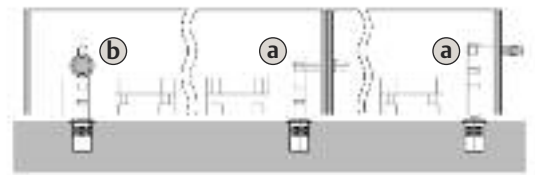

Le rangement à 90°
The 90° degree stacking arrangement



Les panneaux sont rangés avec un angle droit
au regard du rail principal.
Panels are stacked at a right angle with the main profile.

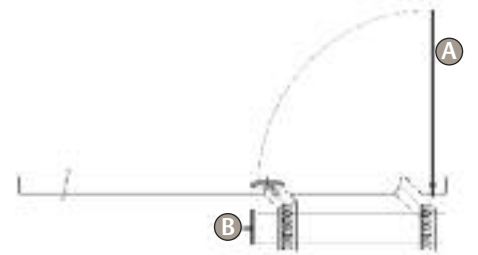

Les panneaux sont rangés parallèles au regard
du rail principal.
Panels are stacked parallel with the main profile.

- Ⓐ Porte va-et-vient fixe sur pivot de sol ou pivot libre.
Fixed swing door on floor closer or on a free swing pivot.
- Ⓑ Panneaux coulissants
Sliding panels.

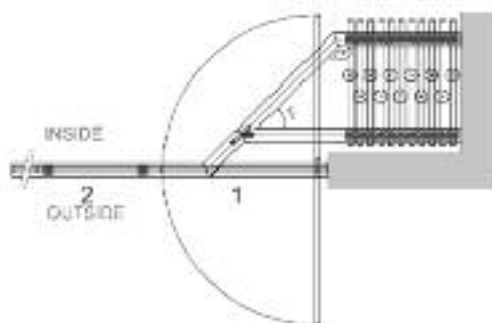

Panneaux rangés derrière un mur. Le premier panneau
est une porte fixe sur frein ou pivot libre.
Panels are stacked behind a wall. First panel is a swing door.

Pour chaque situation spécifique nous offrons une solution !
A solution for all situations !



Coupe du profilé (panneau coulissant) FLEXystack 250
Cross section (sliding panel) FLEXystack 250

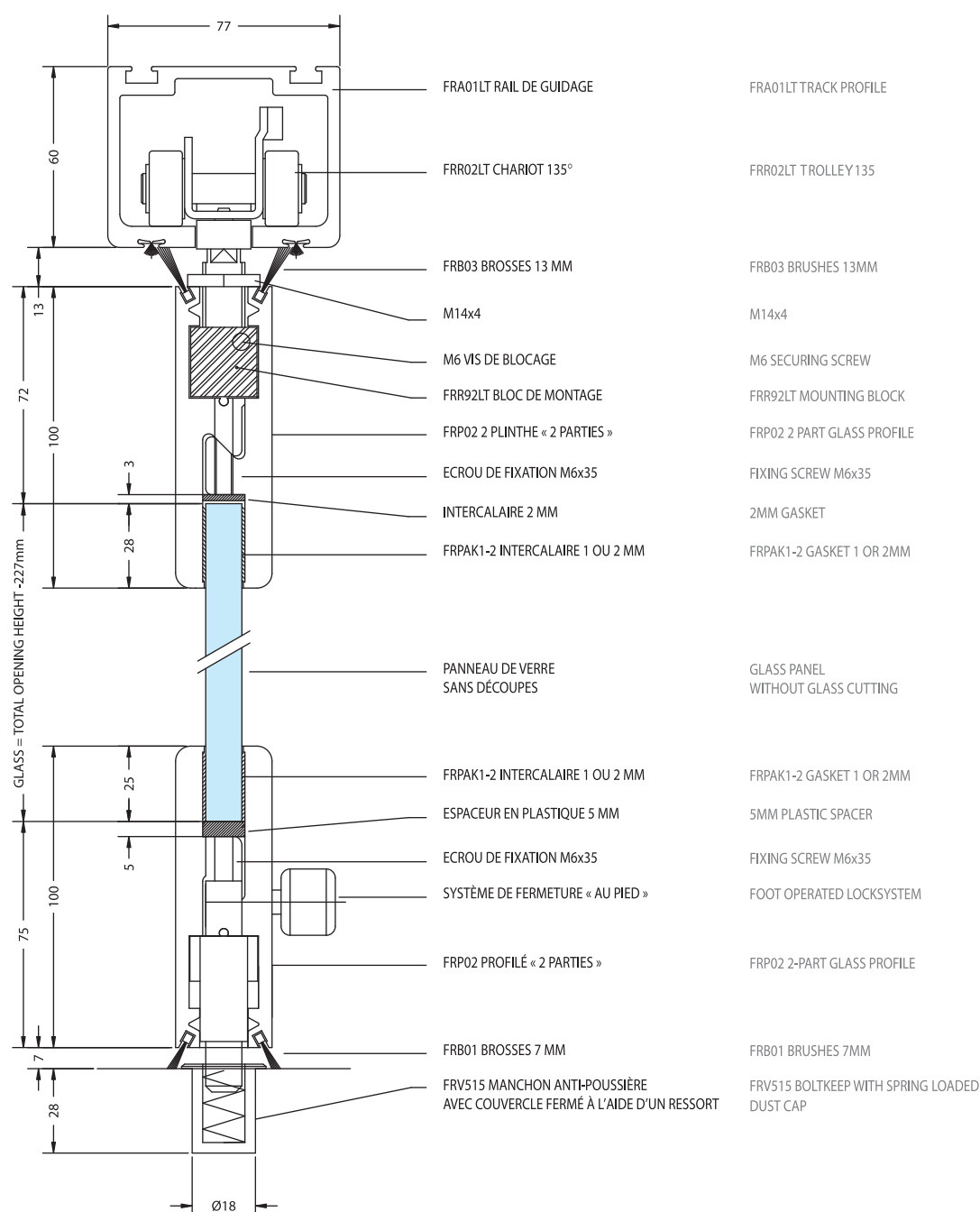

Accessoires

Accessories



Références / References



Chromé brillant
Bright chromium



Chromé mat
Matt chromium

Anneau de tirage
Ring pull

SL27.30

SL27.31



Poignée 'G' pour porte coulissante
'G' shaped handle for sliding doors



Inox brossé
Brushed stainless steel

AMGMODEL/8.15



Poignée 'G' pour porte coulissante
'G' shaped handle for sliding doors

AMGMODEL/10.15



Chromé brillant
Bright chromium



Chromé mat
Matt chromium



Effet Inox
Stainless steel effect

Serrure verticale à crochet avec poignées + gâche plate et cylindre
Vertical hook-lock with handles + flat keep and cylinder

SL93.30

SL93.31

SL93.35

Serrure verticale à crochet sans poignée + gâche plate et cylindre
Vertical hook-lock without handle + flat keep and cylinder

SL94.30

SL94.31

SL94.35

Contre boîtier sans poignée pour serrure SL94
Patch keep without handle for lock SL94

SL95.30

SL95.31

SL95.35

Contre boîtier avec poignées pour serrure SL93
Patch keep with handle for lock SL93

SL96.30

SL96.31

SL96.35

SL27.**

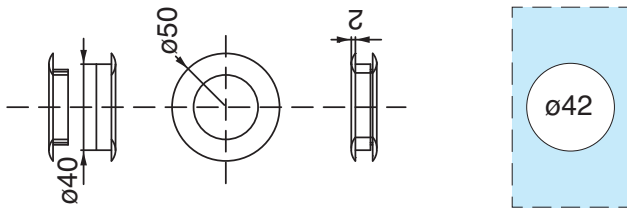

AMGMODEL/**.**

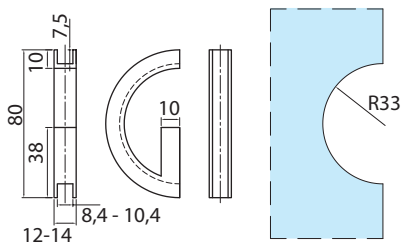

SL93

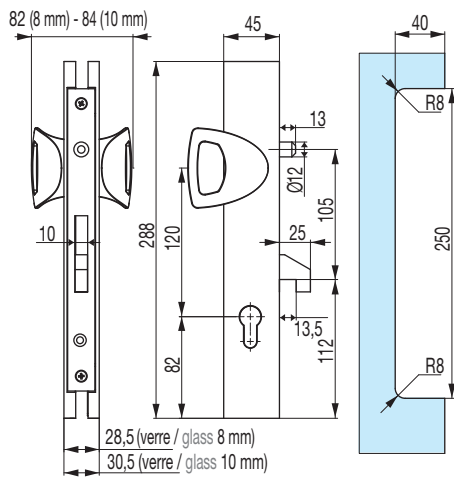

SL94

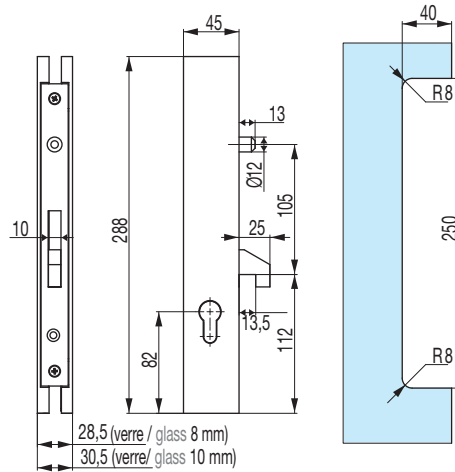

SL96

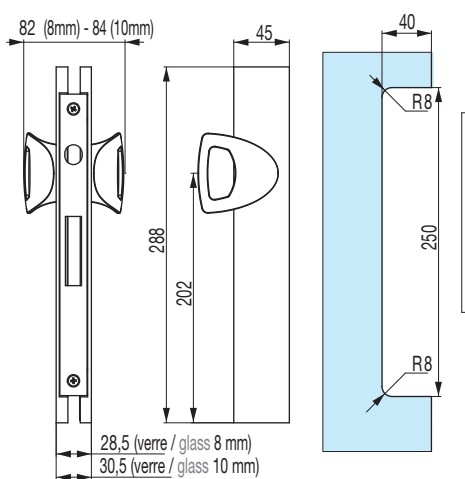

SL95

